

PIEZOSURGERY[®] 3 accessories

LOT 03230006
FLOW ADJUSTER
(50 PCS.)

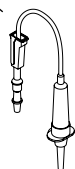

01380002
IRRIGATION BAG
SUPPORT ROD

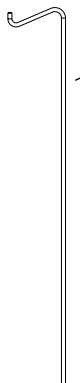

02900040-001
HANDPIECE
SUPPORT

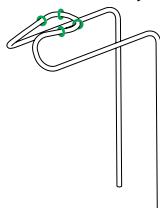

00050002
SCHUKO POWER CABLE
00050016
JAPAN POWER CABLE
00050003
UK POWER CABLE
00050010
AUSTRALIA POWER CABLE

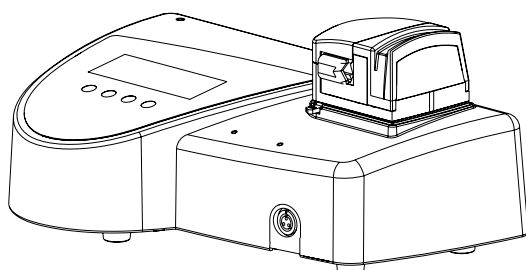
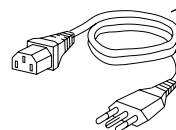

02900039-001
KIT 8x PUMP TUBE (HANDPIECE CORD WITH
METAL CONNECTOR)
02900104-001
KIT 8x PUMP TUBE (HANDPIECE CORD WITH
PLASTIC CONNECTOR)

SN 031200023-001
COMPLETE
HANDPIECE WITH
CORD

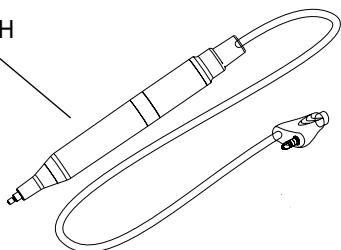

LOT 02900109-001
K8 DYNAMOMETRIC
WRENCH



02900111
RADEL INSERT TRAY
(15 INSERT SLOTS)

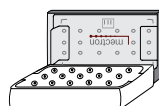

02900037-001
STEEL INSERT TRAY
(5 INSERT SLOTS)



04440007-001
SUITCASE

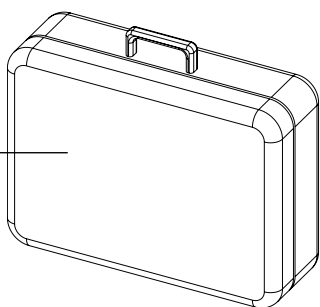

04610004-001
SURGICAL TRAY

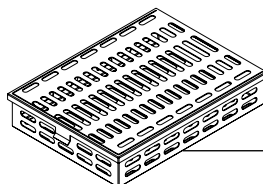

LOT 02900078-001
FOOTSWITCH

